

DOOSAN

**Delivering
cutting-edge
turbine and
generator
technologies**





Doosan - More than innovation

Doosan is a modern and dynamic supplier of high performance steam turbines, generators, and heat exchangers that rank amongst the best products of their kind in today's global marketplace. Our employees draw upon their experience to realize innovation and a customer friendly approach to find and offer the best solutions.

Our expertise is built on over 110 years of experience in the manufacture and continuous development of steam turbines. The production knowledge we've accumulated is incorporated into our product designs today, helping us deliver reliable, efficient, and innovative turbine technologies.

Global interest in Doosan turbines is growing every year, resulting in a rapid increase of our market share. Today, we are a respected and sought-after supplier of steam turbines from 10 MW to 1,500 MW for customers and plants around the world.

Our generators are the most up-to-date machines of their kind, utilizing the latest technology and providing incomparable quality with ratings from 100 MW to 1,500 MW.

We are driven by the desire to provide our customers with optimum efficiency, high reliability, and operational flexibility—all at a reasonable price. Our technology covers all fuel types from fossil fuel and biomass to nuclear and renewables. By covering every possible detail, we design our turbines to exceed your expectations.

Doosan offers a wide range of technologically advanced turbine designs, products, and services for the energy generation field such as equipment supply of turbines, generators, and heat exchangers, turbine generator sets, turbine islands up to turbine machine halls, long-term service, and retrofitting programs. We upgrade our own turbines with cutting-edge technology, as well as non-OEM turbines that utilize Doosan components.

We conduct our business based on a customer-oriented approach: we not only provide technological solutions, but also support ECA financing for our customers.

In Plzen and Changwon, Doosan's global R&D Center, with head office in Plzen, we continue to invest considerable resources into the development of our products and systems.

Whatever the technological and commercial requirements, Doosan can help.

We are driven by the desire to provide our customers with:

- Optimum efficiency
- High reliability
- Operational flexibility

all at a reasonable price

Steam turbines

As a specialized steam turbine supplier, we achieve world-class performance, efficiency, reliability, and maintainability of Doosan steam turbines through effective design and quality manufacturing. Our steam turbine technologies are constantly evolving to meet the changing needs of our customers.

We invest in R&D to continuously enhance the construction of each component, with the ultimate goal of increasing turbine efficiency, lowering fuel consumption, and reducing emissions for minimum impact on the environment.

Our technologies provide:

Optimum exploitation of cooling conditions at the turbine outlet

Long-term sustained efficiency through unique design features

Shorter start-up times through a more flexible thermal design



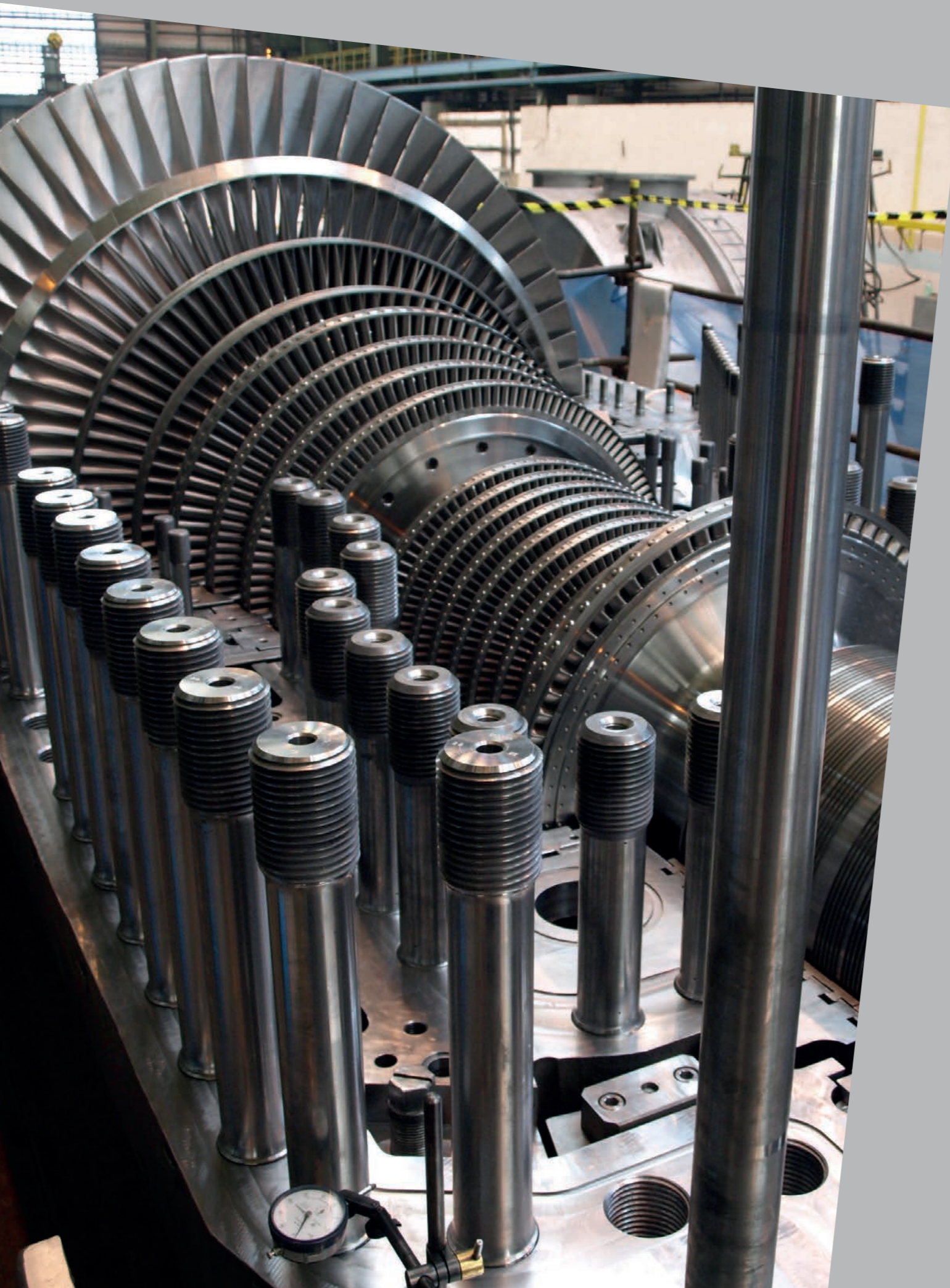

Industrial steam turbines

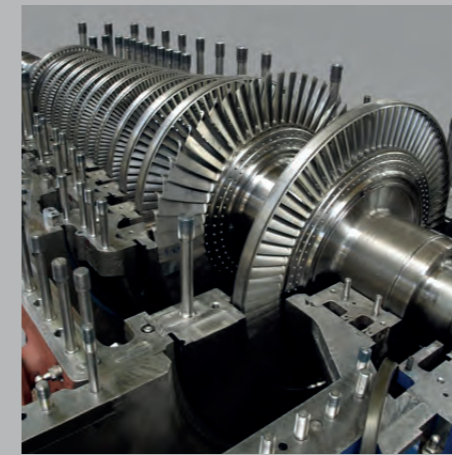

Doosan industrial steam turbines are flexible units that meet the requirements of even the most complex processes in a range of industries, from metallurgy, chemical, pulp and paper, to sugar mills, local heating from cogeneration units, and many more.

The turbines are constructed as single-casing, high-speed turbines, either condensing or back-pressure, in a compact configuration. Single casing steam turbines are usually coupled to the generator via gearbox.

The construction of these turbines allows for the application of one or more controlled steam extraction systems, and a radial or axial outlet into the condenser. These turbines are supplied to the construction site assembled, which simplifies and shortens their installation.

At Doosan, we don't classify turbines as industrial merely according to their output. Instead, we consider the industry and process in which the turbine is going to be employed, so that even a medium-output turbine with industrial steam extraction can be regarded as industrial.

Model	Speed (RPM)	Indicative Range Steam Parameters up to	Configuration	Indicative Output (MW)						
				10	20	30	40	50	60	70
DST-V	Variable speed	acc. to request		[Bar chart showing output from 0 to approximately 35 MW]						
DST-G10	> 6,500	140 bar, 540 °C		[Bar chart showing output from 0 to approximately 35 MW]						
DST-G20	from 4,000 ~ to 6,500	140 bar, 565 °C		[Bar chart showing output from 0 to approximately 65 MW]						
DST-S10	3,000 / 3,600	165 bar, 580 °C		[Bar chart showing output from 0 to approximately 70 MW]						

DST-V – Variable Speed Driver Steam Turbines
 DST-G – Industrial Steam Turbines Connected Via Gearbox
 DST-S – Power Generation Synchronous Steam Turbines

Turbines for medium and large power output

Doosan medium and large output steam turbines for power generation application are designed primarily with the requirements of utilities and heating facilities in mind.

We can tailor our wide range of medium and large output steam turbines to fit the requirements of your project.

- One, two and multiple-core units, with or without steam reheating
- Speeds of 3,000 rpm or 3,600 rpm
- Pure condensing, condensing-extraction, back-pressure, or back-pressure-extraction
- Radial, lateral or axial outlet into the condenser



Doosan follows the principle that a turbine's flow part is always designed according to the specific requirements and conditions of each individual project. To achieve the maximum possible efficiency, we combine our modular structure with operationally verified nodes.

Outlet casings for condensing turbines differ only according to the standard modular last stage blade. The arrangement and performance of steam valves and bearing stands are also fully standardized.

Type	Speed (RPM)	Indicative Range Steam Parameters up to	Configuration	Type	Indicative Output (MW)										
					100	300	500	700	900	1100	1300	1500			
DST-S10	3,000 / 3,600	165 bar, 580 °C		Single-Casing	■										
	3,000 / 3,600	180 bar, 580 °C		Double-Casing	■										
DST-S20	3,000 / 3,600	280 bar, 610 °C		HIP Combined + LP	■	■	■	■	■						
DST-S30	3,000 / 3,600	300 bar, 630 °C		HP + IP + LP		■	■	■	■	■	■	■	■	■	■
DST-N	Half / Full speed	Saturated steam		Nuclear Steam Turbines	■	■	■	■	■	■	■	■	■	■	■

DST-S – Power Generation Synchronous Steam Turbines
 DST-N – Steam Turbines for Nuclear Power Plant

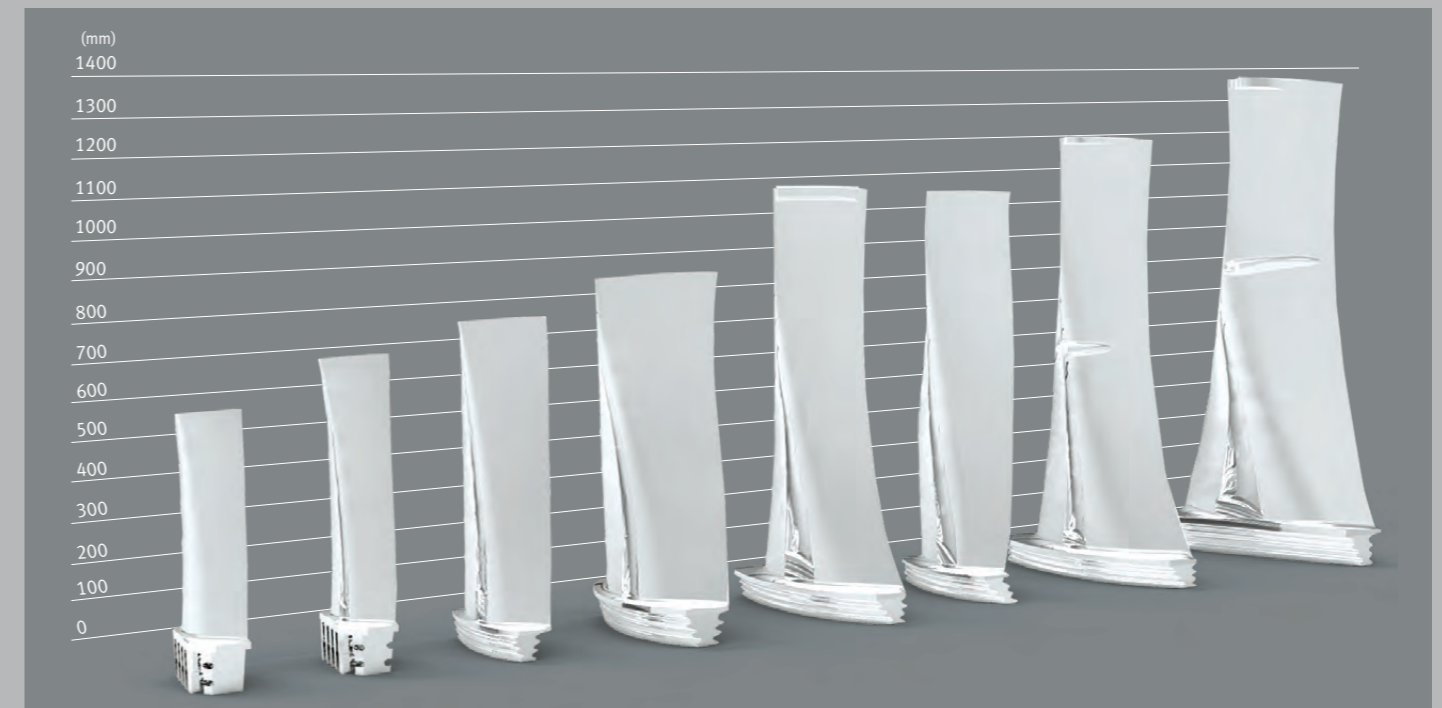

Beyond technology, customer friendly

Doosan steam turbines are based on a modular design that incorporates operationally proven elements, differing only in flow-part dimensions, to provide customers with reliable solution. We optimize our designs to meet individual customer requirements by means of a suitable combination of standardized modular elements and tailor-made design.

Delivering high efficiency

Advanced aero blade design

Doosan has provided customized solutions in both impulse and reaction technology for over a century. Drawing upon our wealth of experience and professional knowledge, we are able to provide advanced blades with three-dimensional design. This enables us to deliver the highest efficiency and years of quality performance.

Our advanced blade is designed with optimized reaction and stage load level through the flow path of steam turbines.

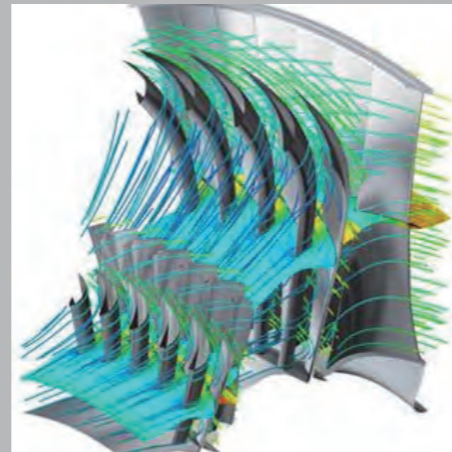

Advanced sealing technology

Sealing technology is very important for modern steam turbines in terms of performance. Doosan's advanced sealing technology can maintain minimized operational clearances and reduce leakage losses.

We provide the most optimized sealing technologies-brush seals, abradable coating, retractable seals, and honeycomb seals-to realize remarkable efficiency improvements.



Maximizing customer's value

Customized solutions

Doosan provides our customers with a wide spectrum of technically progressive and economically effective steam turbine solutions to meet all the specific conditions of individual projects.

Technology to meet all customer's needs

Doosan sides with our customers, listens to your opinions, and creates superior designs to meet all your requirements.

Using welded rotors allows us to manufacture very large low-pressure turbine rotors and improve their dynamic behavior in operation. They also enable fast start-up and loading by reducing stress levels compared to monoblock rotors. Doosan developed special technology for heterogeneous rotor welding to combine materials with optimum properties in each section of the rotor flow path; this produces the creep resistant materials in the front hot section and ductile high strength materials at "cold end." High power output turbines can then be designed in a single casing compact arrangement.

The assembled diaphragm consists of inserted nozzle blades into the outer and inner rings, which are mechanically secured by pins to minimize deformation and improve manufacturing accuracy and the finish surface. This also enables us to achieve the highest flow path efficiency.

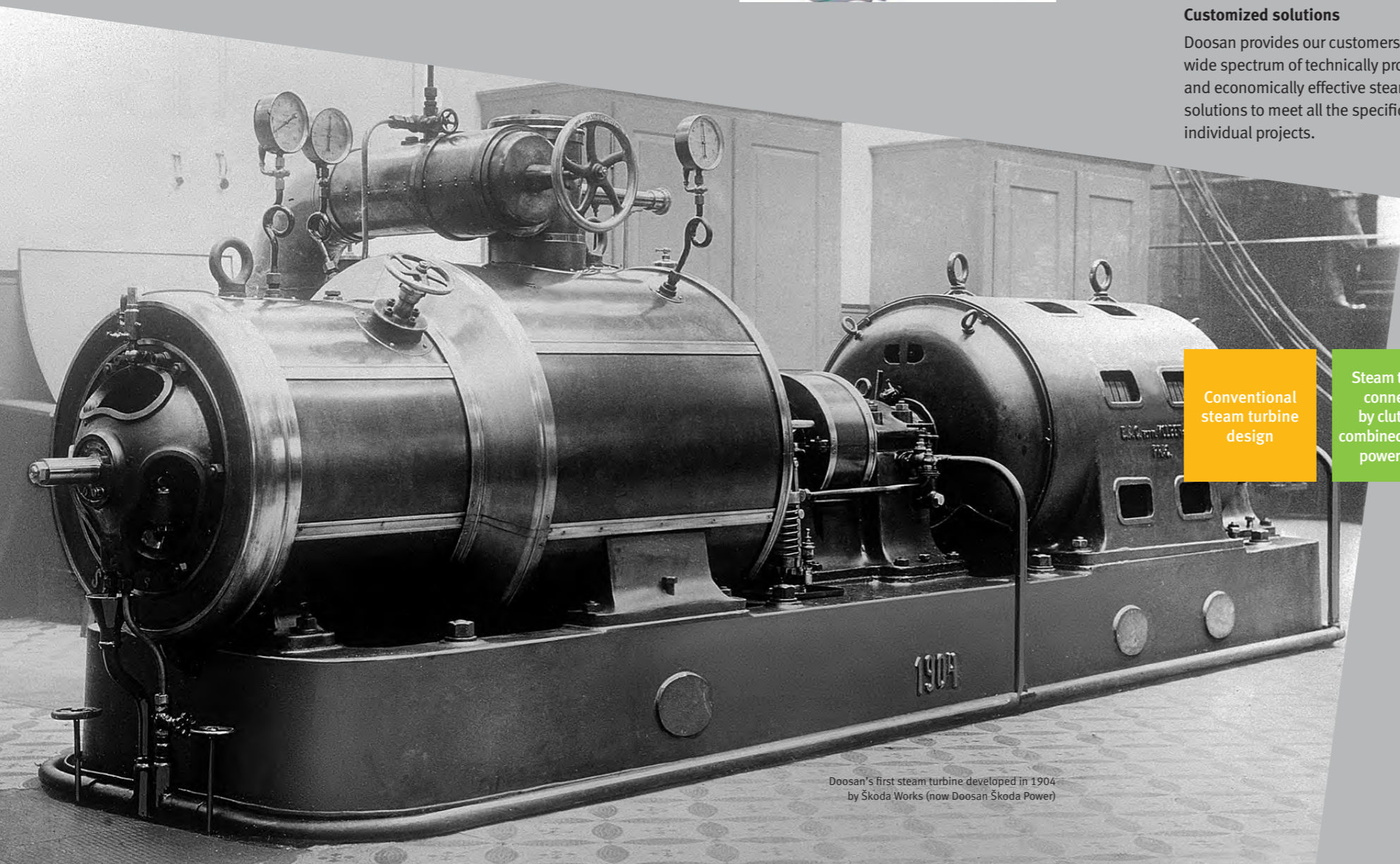

Conventional steam turbine design

Steam turbine connected by clutch for combined heating power plant

Controlled diaphragm design for combined heating power plant

Side exhaust steam turbine design

Axial exhaust steam turbine design

Doosan's first steam turbine developed in 1904 by Skoda Works (now Doosan Skoda Power)



Generator

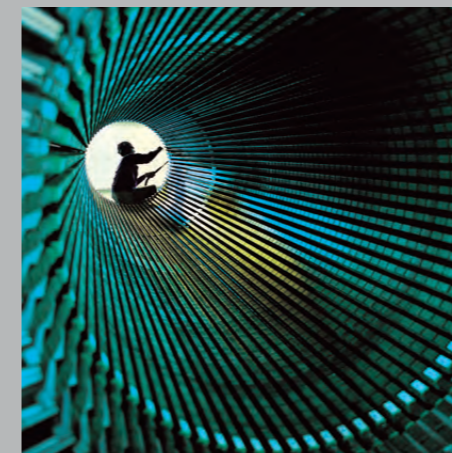

Modern society is almost entirely dependent upon electricity for industrial purposes, leisure, and daily living. To meet the demand for electric power—that is growing at an accelerating rate—Doosan provides a wide range of generators for our customers.

The **stator insulation system** provides the mechanical resilience and voltage endurance required for continuous or daily start & stop duty. The stator insulation design is reliable, proven by its record of superior performance for more than two decades.

The **stator end winding support system** is designed to withstand the severe forces involved in normal and abnormal operation. Stator end winding support systems require little maintenance, and their in-service reliability has been proven.

The **core support system** isolates stator core vibration to minimize generator vibration and noise.

The **retaining rings** of nonmagnetic 18-Manganese/18-Chromium stainless steel resist cracking due to stress and corrosion.

The **Direct-cooled field** promotes uniform temperature distribution throughout the windings to prolong insulation life.

The **stator winding support structure** features top wedges and ripple springs to secure the stator bars in the slot, eliminating bar vibration to maximize insulation life and reduce maintenance requirements.

Low-loss laminated silicon steel minimizes electrical loss within the core and improves the generator efficiency.

DS-DEX (Doosan Digital Excitation System) is a static, digital, potential source excitation system, utilizing state-of-the-art hardware and software technology.

DS-DEX can meet a wide range of generator ratings by virtue of its open architecture with standardized, modular components and can be applied to generators driven by all types of turbines.

Presently, Doosan is applying advanced state-of-the art technology that integrates all necessary factors of design, manufacturing, and quality control, to supply customers not only with a machine, but also total satisfaction.

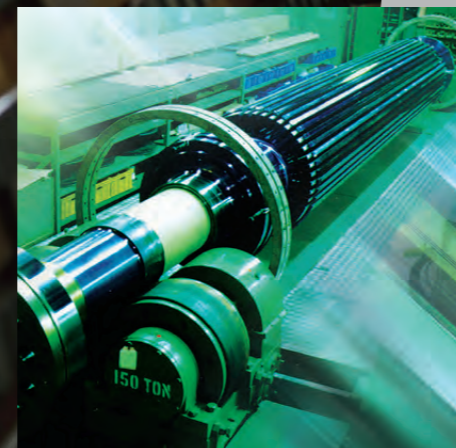
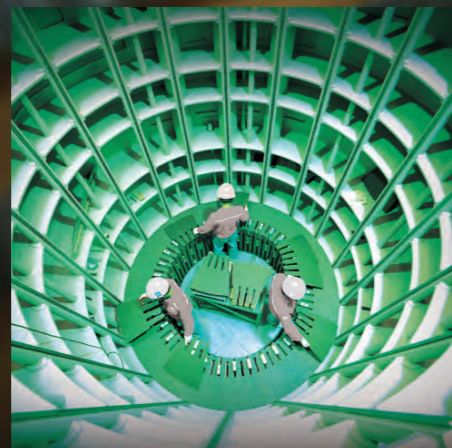

Model	Cooling	Speed (RPM)	Capacity (MVA)	Voltage
DGen-A	Air	3,000	110 ~ 200	10.5 ~ 15.75 kV
		3,600	110 ~ 200	12.5 ~ 18 kV
DGen-H	Hydrogen	3,000	200 ~ 500	15 ~ 19 kV
		3,600	200 ~ 510	18 ~ 21 kV
DGen-W	Hydrogen	3,000	400 ~ 1,390	21 ~ 30 kV
		3,600	450 ~ 1,240	19 ~ 30 kV
DGen-N	Water	1,500	650 ~ 1,700	18 ~ 27 kV
		1,800	770 ~ 1,700	22 ~ 24 kV

Condensers and heat exchangers

To achieve the best efficiency for steam cycles, the highest efficiency condensers and heat exchangers are required. Doosan designs and produces state of the art condensers and heat exchangers for all types of steam turbines.

Through decades of experience with the thermal cycle design as STG OEM, the design of condensers and heat exchangers meets all customer requirements with regard to size, price, layout and overall thermal cycle optimization.

Our condensers and heat exchangers comply with commonly used standards including Heat Exchange Institute (HEI) Standards and other design standards for pressure equipment, including PED, EN Code, ASME Code, and AD-Merkblatt.



Condensers

The design and manufacturing of condensers is offered for any size and type of steam turbine. Based on years of research and application experience, the optimum condenser type with appropriate supports and connection to a steam turbine is selected. Materials including condenser tubes are selected based on quality of cooling water and condensate. Through experience with hundreds of successful projects, we can also deliver condensers with all the necessary auxiliary equipment.

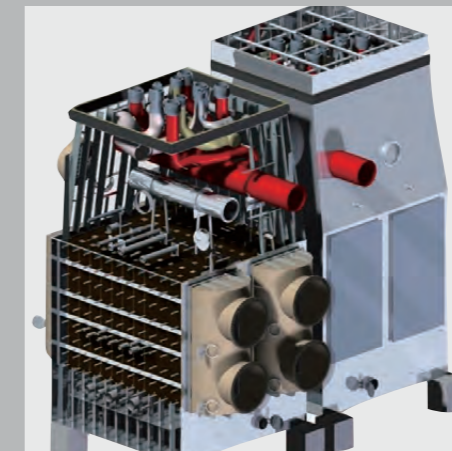

Heat exchangers

District water heater

Our district water heater design is based on extensive customer feedback and takes into account modern trends and features. Doosan district water heaters with U-tubes or straight tubes are designed to meet stringent district heating requirements and achieve the highest possible efficiency of entire cycle.

Regenerative LP & HP heaters

The design of regenerative heat exchangers of Doosan design use latest findings from our own research and includes all modern features such as integrated desuperheaters and subcoolers. Materials and design are optimized for thermal loading to meet customers' price and layout expectations.

Steam jet ejectors

Based our own unique design of steam jet ejectors, we offer highly efficient and robust alternative to water ring vacuum pumps. The vent steam condenser is integrated in the steam jet ejectors condenser itself. This solution saves space and reduces total investment cost.

Retrofits

Doosan offers modernization of obsolete condensers by either using modules with new tube bundles incorporated into the existing shell or by replacing the entire condenser.

Replacement of outdated LP/HP heaters with new modern design can be completed without any significant changes in a steam turbine machine hall.

Main products:

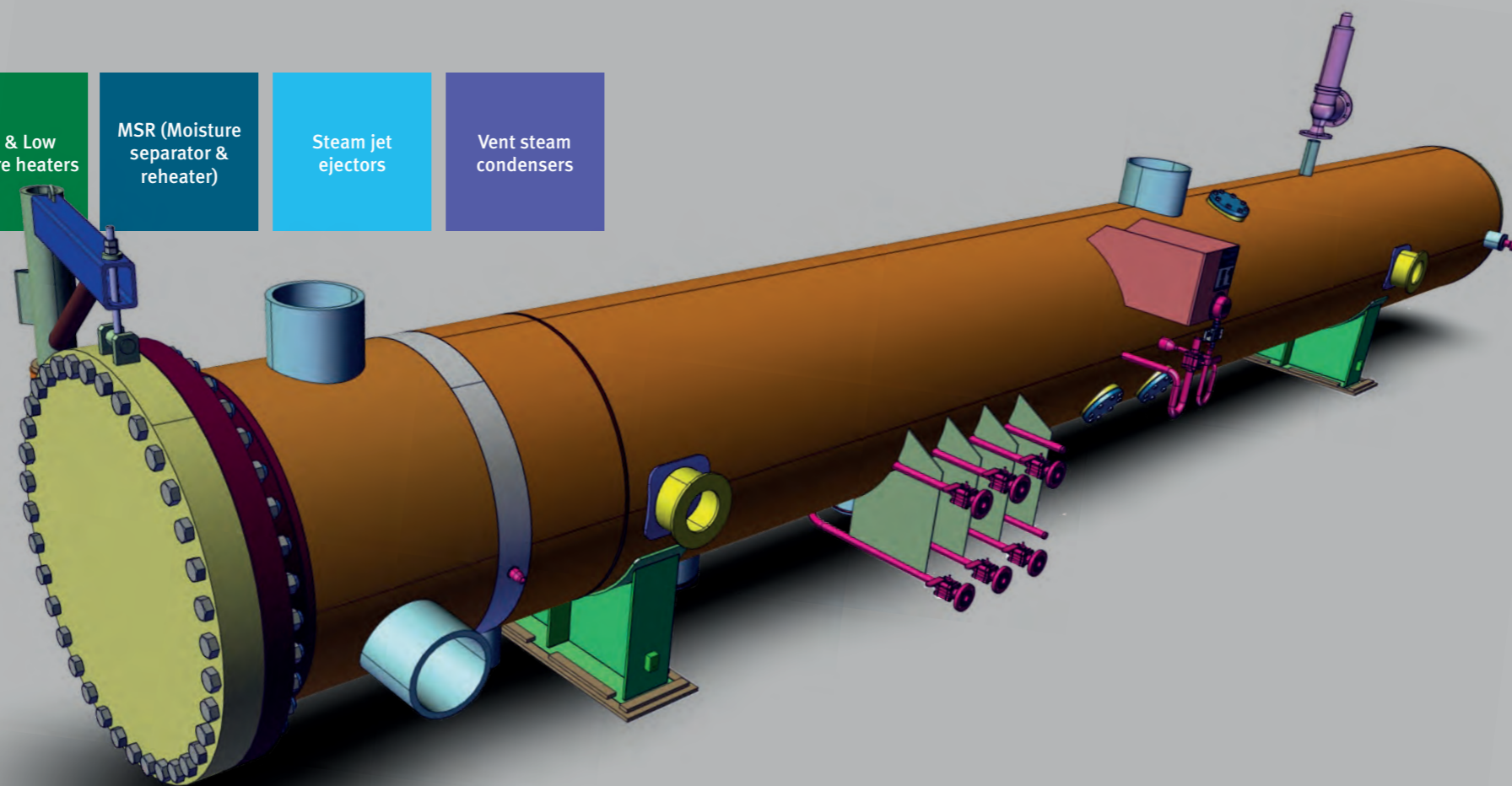

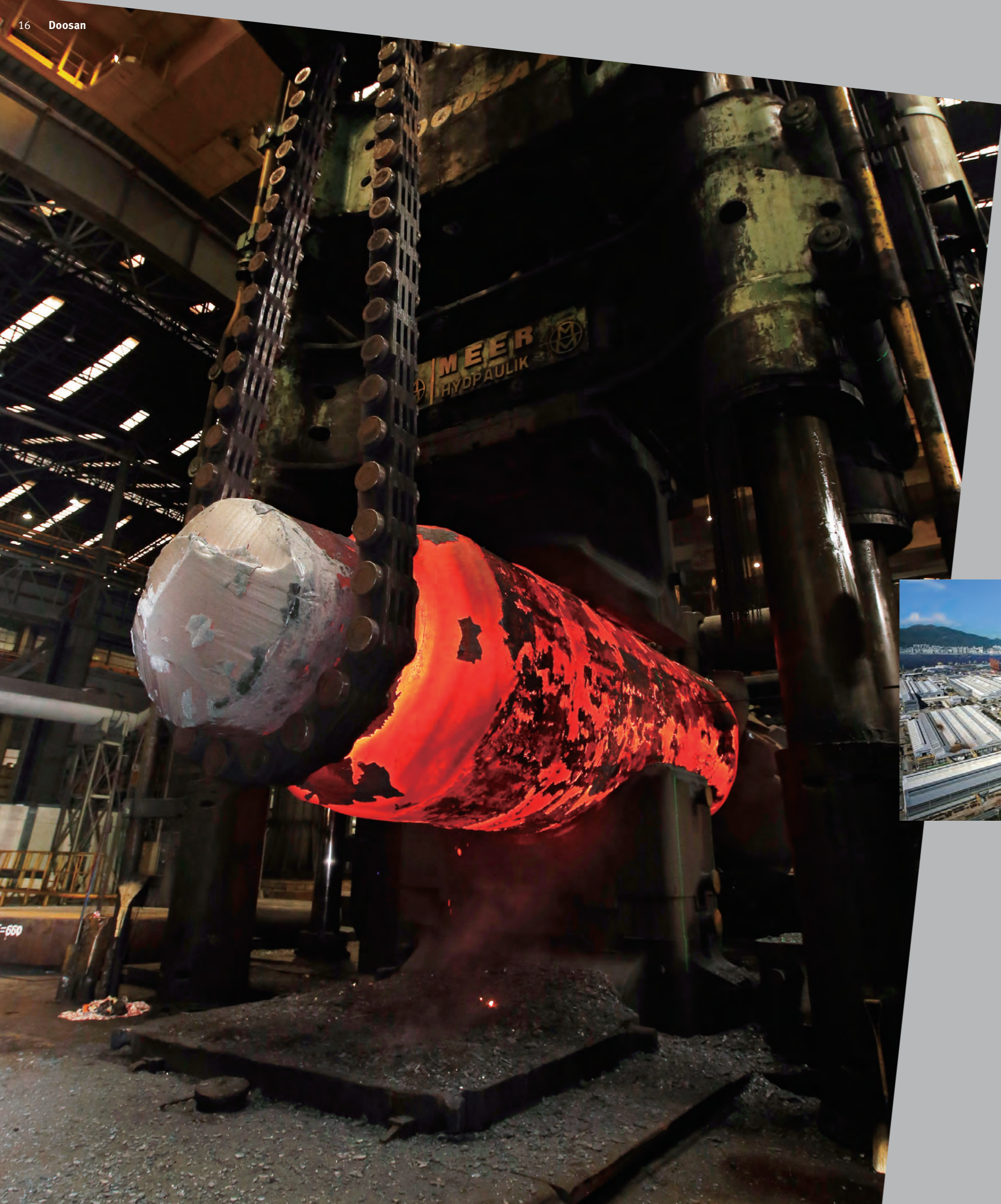

Manufacturing excellence

Doosan strategically picked our manufacturing center's location to consistently develop and produce high quality products that meet the specific needs of various customers.



Changwon plant in Korea



Pizen plant in Czech Republic



Doosan VINA plant in Vietnam

As a fully vertically integrated power plant manufacturer, we can cover all the processes from casting and forging to equipment manufacturing and whole turnkey EPC. We understand any issue in our field, from basic fundamentals to specific applications.

We can provide competitive solutions as we produce steam turbines, generators, and all types of heat exchangers in our own facility.

Our robust and certified management system supports our on-time delivery of products and services, and reinforces our commitment to quality control, environmental protection, and health and safety at work.

Full range of services for our customers

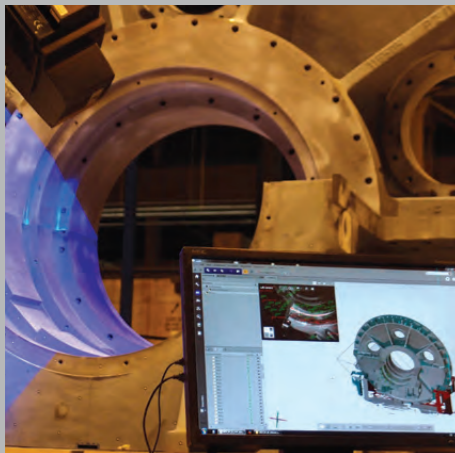

Doosan understands the operational challenges you face on a day-to-day basis. This is why we offer entire range of services to help our customers find maximum potential and benefit from your plants. We are ready to assist our customers and solve any problems they may encounter.

Maintenance repair overhaul

- Spare part supply and management
- Expert services applying advanced diagnostic tools
- Troubleshooting
- Overhauling and repairing for turbine hall including generator, condensate and feedwater equipment
- Service hotline in case of emergencies
- Residual lifetime assessment for turbine and generator
- Measuring of performance degradation
- Advance repair technology
- On-site machining

Long-term services agreement

- Partnership with OEM
- Remote monitoring
- Predictable long-term maintenance costs
- Optimized maintenance programme and costs
- Guaranteed availability or reliability
- Overhauling in shortest possible time

Retrofit and modernization

- Turbine and generator retrofit including OEM and non-OEM equipment improves performance and extends lifetime.
- Return on investment 3-5 years
- Use of original foundation with minor modification
- Replacement of old steam path with 3D blading
- Reverse engineering for non-OEM turbine and generator
- Retention of original turbine design and dimensions (bearing span, etc.)
- Use of original condenser and heaters
- Control system upgrade
- Generator rewinding of old stator and/or rotor coils with new materials, enhanced insulation, and greater capacity

Eraring power station, Australia

Non-OEM upgrade project with electrical output and performance increase from 660MW to 750MW

"We satisfied with its operating and performance without any problems."

Managing director,
Eraring power station

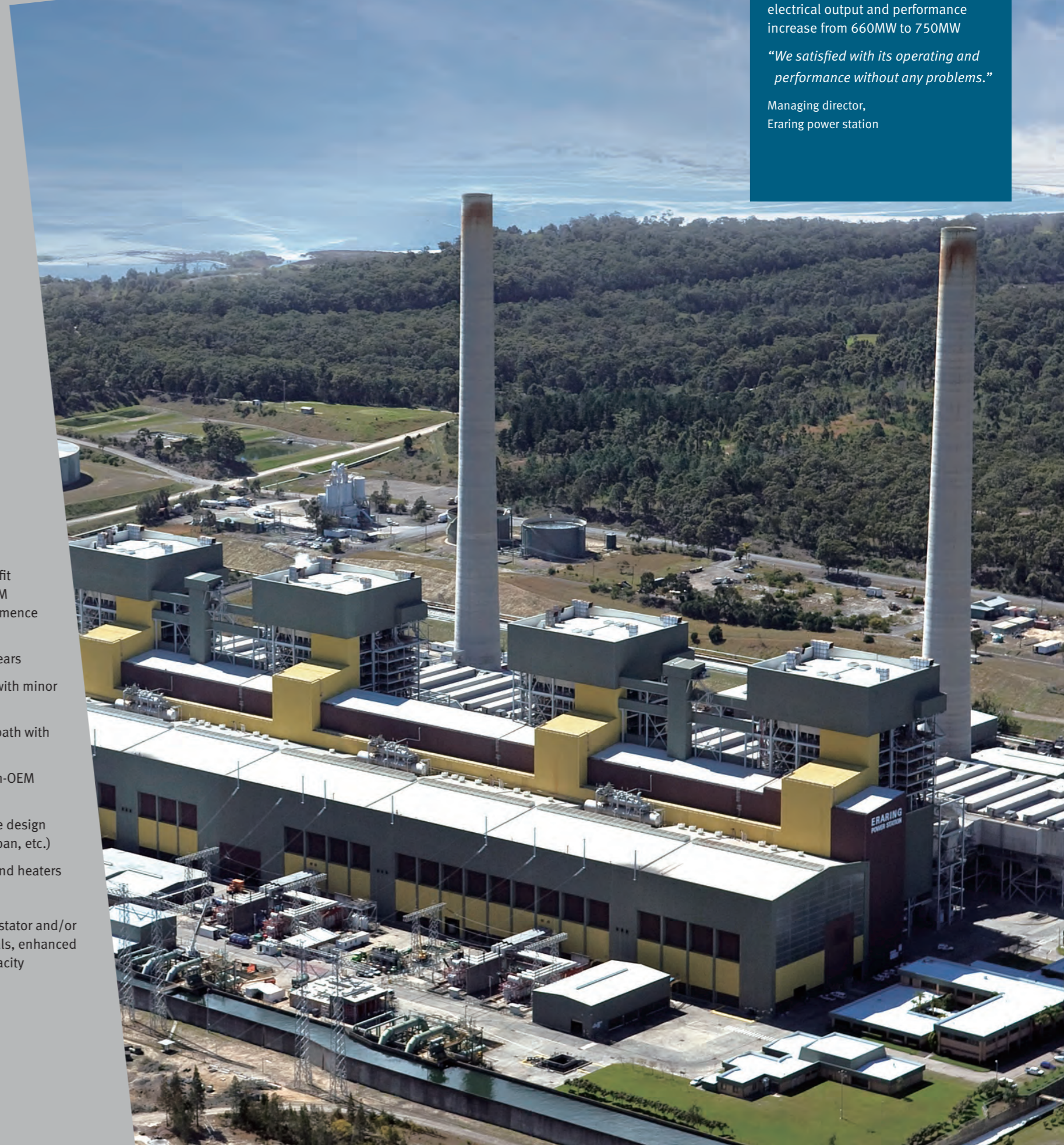

A flexible approach

Doosan provides a range of products and services for power engineering and industrial applications, including supply of steam turbines, generators, and heat exchangers, turbine-generator sets, and turbine islands up to turbine machine halls, all of which are based on our proprietary design, research, and development.

We design and manufacture products for a wide range of applications, including:

Renewable power plants – biomass, waste-to-energy, solar, etc.	Combined cycle power plants and add-on projects	Fossil fuel-fired power plants, including supercritical (e.g., coal)	Nuclear power plants
Other applications include:			
Utilities and municipalities	Industry (sugar, pulp and paper, chemistry, metal, oil and gas, etc.)	District heating and cogeneration plants	



Turnkey delivery

Doosan expertise can help you at every stage of your turbine project, from helping with initial investment planning and project documentation to commissioning the plant for commercial operation.

We work hand-in-hand with our customers to deliver turnkey projects that take your investment from design to commercial success. We have developed standardized project solutions and proven design principles for even the most advanced steam parameters, including supercritical and ultra-supercritical.

Our scope of supply includes equipment supply of steam turbines, generators and heat exchangers, turbine-generator sets, and turbine islands up to turbine machine hall including civil work mainly TG foundation, erection, commissioning, and guarantee performance tests. You can be assured that we are capable of complete turnkey delivery.



We offer:

- High operating reliability and flexibility
- Easy maintenance for shorter shutdowns
- High reliability for longer intervals between overhauls
- After sale service, including long-term service contracts
- Ongoing modernisation programs offered in line with the latest developments
- Continuous enhancements in new construction techniques
- Comprehensive in-house research and development facility, covering all major theoretical disciplines, with an emphasis on fluid dynamics research
- Application of technical diagnostics, including remote monitoring

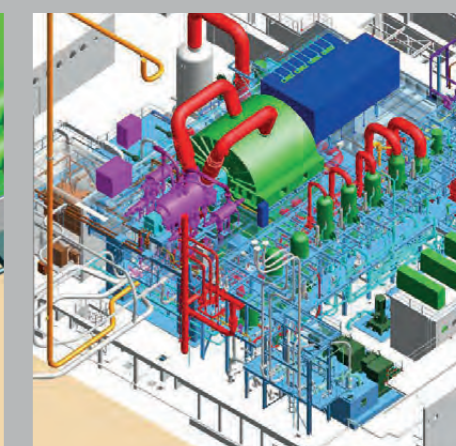
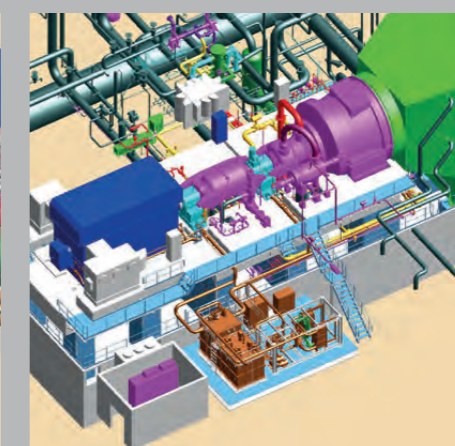
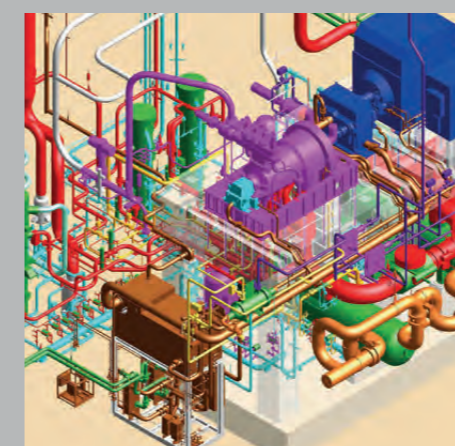

The way we work

At Doosan, we understand that our products and services are only as good as the people behind them, so we work hard to recruit, train, and develop the very best in the industry.

Our people are at the center of who we are, so we take genuine care in their development, making their cultivation our long-term priority. We are also committed to the education of our youth, to ensure we develop a new pipeline of technology, design, engineering and project management talent and retain an unparalleled breadth of knowledge within our company.

Transferring knowledge and experience to the next generation strengthens the stability and longevity of our business and gives our customers reassurance that our engineering competency is sustainable for the long term.

Corporate social responsibility

In all territories in which we operate, we embrace customer and community visions for sustainability. Doosan corporate social responsibility (CSR) program is built on three pillars: education, sustainability and community. This provides us with a framework through which to promote excellence in science, technology and engineering education, minimize the environmental impact of our operations, prioritize product quality, health and safety, and make a positive difference in our local community.

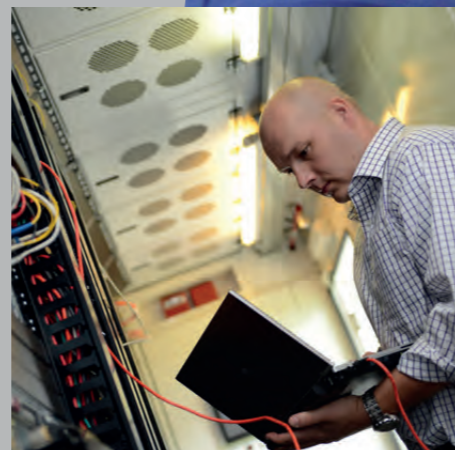
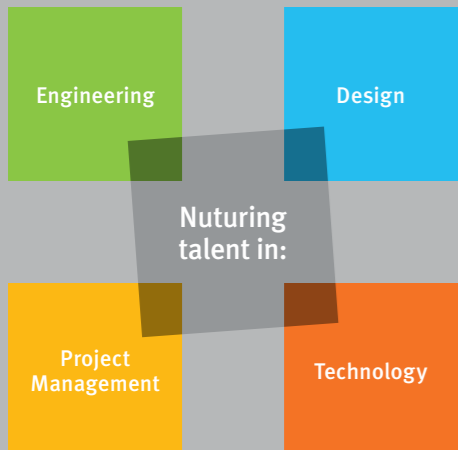

With our extensive global network,
Doosan meets various customer needs around the world.

● Subsidiaries
● Branch Offices



Global Network

HEAD OFFICE & CHANGWON PLANT
22 Doosan Volvo-ro Seongsan-Gu,
Changwon, Gyeongnam 51711, Korea
Tel +82 55 278 6114, 7114
Fax +82 55 264 5551~2

Seoul Office
Doosan BundangCenter
155, Jeongjail-ro, Bundang-gu,
Seongnam-si, Gyeonggi-do, Korea

Doosan Škoda Power
Tylova 1/57, 301 28, Plzen,
Czech Republic
Tel +420 378 185 000

Doosan Power Systems Arabia
P.O. Box 7937, 1st Floor Al Hamra
Plaza, Palastin Street, Jeddah
21472 Saudi Arabia
Tel +966 012 261 3074

Doosan ATS America
11360 N. Jog Road Palm Beach
Garden, Florida 33418, U.S.A
Tel +1 561 572 9090

Doosan VINA
Dung Quat Economic Zone,
Binh Thuan, Binh Son,
Quangnai, Vietnam
Tel +84 55 3618 900

Global Marketing Office

Tokyo Office
Mita Kokusai Bldg, Room 2413, 1-4-28
Mita, Minato-Ku, Tokyo 108-0073, Japan
Tel +81 3 3452 5451

Riyadh Office
Office No. 205&206, Akariya the Plaza,
Olaya Street, Riyadh, 11423,
Kingdom of Saudi Arabia
Tel +966 1 419 1696

Abu Dhabi Office
P.O. BOX 27767, Al Ghaith Tower, Suite
508 Hamdan Street, Abu Dhabi, U.A.E.
Tel +971 2 627 6273

Dubai Office
30th Floor, H Office Tower Sheikh Zayed
Road, Dubai, P.O Box : 11859, U.A.E
Tel +971 4 327 5545

Cairo Office
2nd Floor, Land Mark Building,
67 El Teseen St., 5th Settlement,
New Cairo, Egypt
Tel +202 2613 1038

Hanoi Office
Daeha Business Center, #1101,
360 Kim Ma Street, Ba Dinh District,
Hanoi, Vietnam
Tel +84 90 463 4023

Bangkok Office
M-Thai Tower, 10th Floor, All Seasons
Place, 87 Wireless Road Phatumwan,
Bangkok 10330, Thailand
Tel +66 2 654 0690

Jakarta Office
Plaza Bapindo, Mandiri Tower 20F,
Jl Jend Sudirman No 54-55, Jakarta,
Indonesia
Tel +62 21 2995 0101

Manila Office
Room. 1109~1110, 11F, Ayala Tower
one and Exchange plaza, Ayala
Triangle, Ayala Ave, Makati city
Tel +63 2 949 8060

Taipei Office
8F-7, No.495, Gunagfu South Road,
Xinyi Dist., Taipei, Taiwan, R.O.C
Tel +886 2 2720 2050

Beijing Office
Gateway Plaza. Tower B,
19th Floor, No.18 Xiaguangli
North Road, East Third Ring,
Chaoyang District
Beijing, 100027, China
Tel +86 10 8454 7136

Shanghai Office
Rm 2903A, Gubei International
Fortune Center, No. 1438,
Hong Qiao Road, Chang Ning District,
Shanghai 201103, China
Tel +86 21 5877 8696

Frankfurt Office
7th Floor, Arabella Center Lyoner
Strasse 44-48 60528 Frankfurt
am Main, Germany
Tel +49 69 69 5004 0

New Jersey Office
400 Kelby Street, Parker Plaza 10th
Floor, Fort Lee, NJ 07024, U.S.A.
Tel +1 201 944 4554

DOOSAN

Doosan Enerbility

22 Doosan Volvo-ro Seongsan-Gu,
Changwon, Gyeongnam 51711, Korea
(T) +82 55 278 6114, 7114, (F) +82 55 264 5551~2
www.doosanenerbility.com

Doosan Škoda Power

Tylova 1/57 Plzen, 301 28
Czech Republic
(T) +420 378 185 000, (F) +420 378 185 910
www.doosanskodapower.com